



**DANGER**



**THIS TOOL FOR USE BY LICENSED OPERATORS ONLY.  
READ AND OBEY ALL SAFETY AND OPERATING  
INSTRUCTIONS BEFORE OPERATING TOOL.**



**MODEL 721 TOOL  
OPERATOR'S  
SAFETY & OPERATING  
INSTRUCTION MANUAL**



**SINGLE SHOT, LOW VELOCITY  
PISTON TYPE FASTENING TOOL**



**DANGER**



**THIS TOOL IS TO BE USED ONLY BY PROPERLY TRAINED AND LICENSED OPERATORS.**

**YOU MUST SUCCESSFULLY COMPLETE THE RAMSET TRAINING PROGRAM FOR THE TOOL AND OBTAIN A CERTIFIED OPERATOR'S LICENSE BEFORE HANDLING, LOADING OR OPERATING THIS TOOL.**

**ATTEMPTING TO HANDLE OR OPERATE THIS TOOL WITHOUT PROPER TRAINING AND LICENSING CAN RESULT IN SERIOUS INJURY TO THE OPERATOR OR BYSTANDERS.**

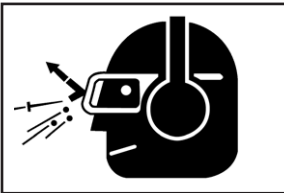

**Operator's and bystanders must wear eye and hearing protection.**

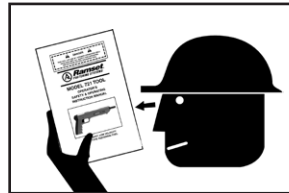

**Read manual before operating tool.**

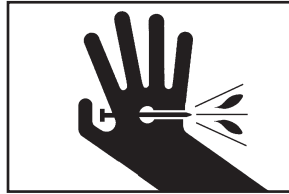
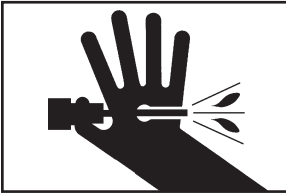

**Never close tool with hand over fastener loading end of the tool. A serious hand injury from penetration by the piston or a discharged fastener could result.**



**DANGER**



Just as no one can merely read a book about driving an automobile and then hope to drive one safely, no one should attempt to use any Ramset tool without adequate, competent personal instruction. And just as one must be licensed to drive an automobile, one must also be licensed to use a powder actuated tool. No automobile instruction book or instructor can forewarn a learner against all possibilities and emergencies, nor can Ramset instructors and printed material detail all possible conditions surrounding the use of Ramset tools and products.

**Responsibility for the safe and proper use of this tool rests with the tool user and the employer.**

## Preparation

### Acceptable Base Materials

Powder actuated fastening is suitable for use in the following base materials only:

- Poured Concrete
- Structural Steel
- Masonry Joints (see page 8)

Never attempt to fasten into any other type of material. Fastening into other materials can cause blindness or other serious injury.

### Unacceptable Base Materials

Never attempt to fasten into very hard or brittle materials such as cast iron, tile, glass, or rock of any type. These materials can shatter, causing the fastener and/or base material fragments to fly free and cause serious injury to the tool operator and others.

Never fasten into soft base materials, such as drywall or lumber products. These materials may allow the fastener to travel completely through and out the other side, endangering those in the path of the fastener.

Never fasten into any base material that does not pass the Center Punch test. Failure to assure the suitability of the base material can result in serious injury to the eyes or other body parts.

## Center Punch Test

**ALWAYS WEAR SAFETY GOGGLES WHEN PERFORMING THIS TEST.**

1. Always check the material being fastened into for hardness before attempting any fastening operation.
2. Using a fastener as a center punch, strike the fastener against the work surface using an average hammer blow and check the results.

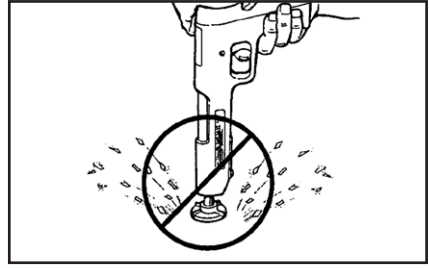

**NEVER FASTEN INTO VERY HARD OR BRITTLE MATERIALS**

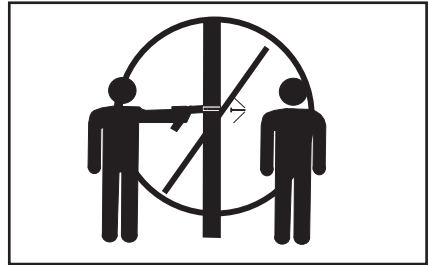

**NEVER FASTEN INTO SOFT MATERIALS SUCH AS DRYWALL**

## Center Punch Test Results

1. If the fastener point is flattened, the material is too hard for a powder actuated fastening.
2. If the fastener penetrates the material easily, the material is too soft.
3. If the material cracks or shatters, the material is too brittle.
4. If the fastener makes a small indentation into the material, the material is suitable for fastening.

**Loads & Load Selection Safety**

1. Always make a test fastening after being sure that the base material is suitable for powder actuated fastening. Failure to determine the correct power level to be used may result in the use of excessive power, allowing the fastener to pass completely through the work material, causing serious or fatal injuries to others who may be in the path of the fastener.
2. Color-blind operators must always select loads by number to prevent use of an incorrect load for the same reasons as in #1 above.

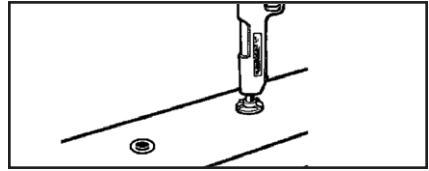

**ALWAYS MAKE A TEST FASTENING**

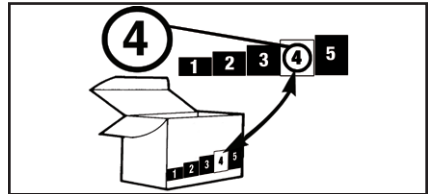

**COLOR-BLIND OPERATORS MUST ALWAYS SELECT LOADS BY NUMBER**

**Workplace Safety**

1. Operators and bystanders must always wear approved eye protection and approved hearing protection. Failure to do so may result in blindness or serious eye injury from flying debris and loss of hearing from constant or repeated unprotected exposure to fastening noise.
2. Always keep the work area clear of bystanders and unnecessary materials that could interfere with safe tool operation. Operating the tool in a congested or cluttered area may affect your ability to operate the tool safely.
3. Never operate tool if flammable or explosive materials are nearby. Powder loads burn and create sparks when fired and could ignite these materials or fumes.
4. Always post warning signs within 50 ft. of the area where fastening is to be done. Sign must state: "WARNING - Powder Actuated Tool In Use". Failure to warn others may result in serious injury to them. Contact Ramset at 1-800-241-5640 to obtain this sign.



**KEEP WORK AREA CLEAR OF BYSTANDERS AND CLUTTER**



**NEVER OPERATE THE TOOL AROUND FLAMMABLE OR EXPLOSIVE MATERIALS**



**ALWAYS POST WARNING SIGNS**

**Tool Handling Safety**

1. Always be sure tool is operating properly before attempting to use it. Follow the “Daily Function Check” shown to the right and described on page 9.
2. Always load tool using a power load selected directly from a box indicating the power load type and number. Never attempt to use loose loads that could be mis-identified.
3. Never carry loose loads in pockets with pins or other hard objects.
4. Never load a tool unless you intend to immediately make a fastening. *Loading a tool and leaving it unattended in the work area can result in the tool being accidentally discharged by others.*
5. Never place your hand or any other body part over the fastener loading end of the tool. *Serious hand injury could result from being struck by either a fastener or the tool piston should the tool be accidentally fired.*
6. Always store the tool unloaded and keep the tool and the loads securely locked in a tool box. Keep keys away from children and unlicensed persons.
7. Always keep the tool pointed away from yourself and others.
8. Never carry a loaded tool around the work area.
9. Never allow anyone not trained to use the tool.
10. Never engage in horseplay with the tool.
11. Using the tool in poorly ventilated areas, cleaning tool or handling loads may result in exposure to lead or other substances known to cause birth defects, and other physical harm. Have adequate ventilation at all times and wash thoroughly after exposure.

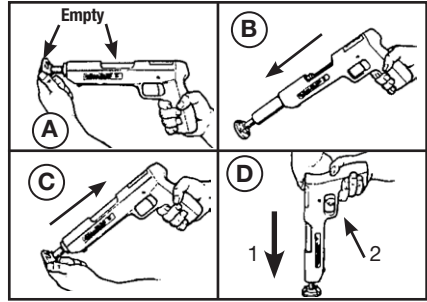

**ALWAYS DO A DAILY FUNCTION CHECK BEFORE LOADING TOOL**

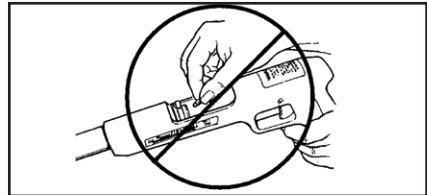

**NEVER LOAD THE TOOL UNLESS IT IS TO BE USED IMMEDIATELY**

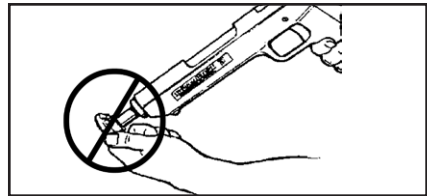

**NEVER PLACE HANDS OR BODY OVER MUZZLE OPENING**

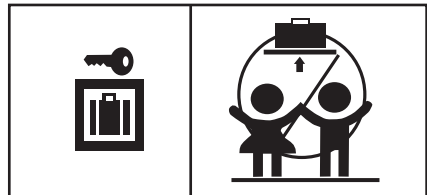

**KEEP TOOL LOCKED & OUT OF THE REACH OF CHILDREN**

## FAILURE TO FOLLOW INSTRUCTIONS CAN CAUSE INJURY TO THE TOOL OPERATOR OR TO BYSTANDERS.

### Fastener Driving Safety

1. Only use the tool for fastening into a suitable base material.
2. Never fire the tool without a fastener. *Firing a tool without a fastener will cause the piston to strike the work surface, and may cause serious injury to you and others in the work area.*
3. Always use the spall guard whenever possible to minimize flying particles or debris.
4. Always hold the tool perpendicular to and firmly against the work surface when making a fastening. *Failure to do so could allow a fastener to ricochet.*
5. Never attempt to drive a fastener close to an edge or to another fastener. *See page 8 for guidelines.*

### ALWAYS FOLLOW THE MISFIRE PROCEDURE.

If the tool does not fire after pulling the trigger, continue to hold the depressed tool against the work surface for at least 30 seconds. Then carefully open the tool, remove the load, and put it in a can of water or other non-flammable liquid. Never carelessly discard live loads into a trash container.

If the tool becomes stuck or jammed with a live powder load, keep the tool pointed in a safe direction, and immediately tag it, "Danger- defective - do not use". Lock the tool in a tool box and call your local Ramset distributor for assistance.

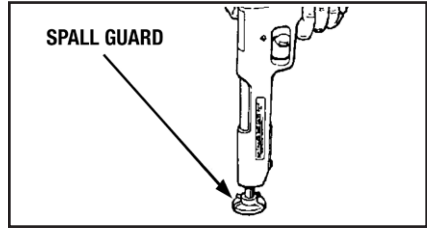

USE SPALL GUARD WHENEVER POSSIBLE

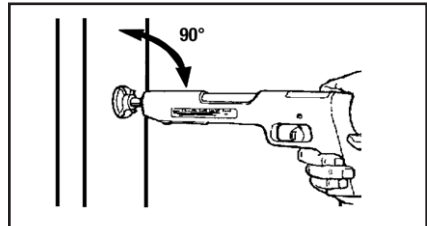

ALWAYS HOLD THE TOOL PERPENDICULAR TO THE WORK SURFACE

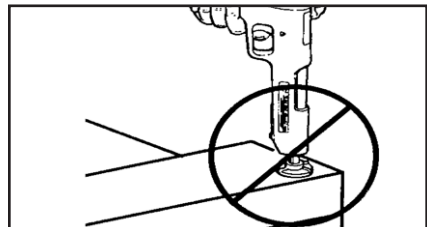

NEVER DRIVE A FASTENER CLOSE TO AN EDGE

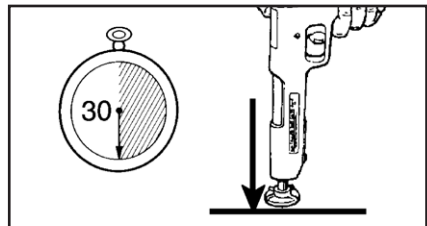

HOLD THE TOOL FIRMLY AGAINST THE WORK SURFACE FOR AT LEAST 30 SECONDS

# FASTENERS / LOADS

Your Ramset Model 721 Tool uses only the Ramset fasteners and loads shown below or listed for the tool in the Product Catalog.



**DANGER**



Never use any other types of fasteners or loads in the Model 721 Tool. Use of other types of fasteners or loads may cause unintentional load discharge, damage the tool, cause poor fastening performance, or create a risk of serious injury to the operator or bystanders.

## FASTENERS

**.300 HEAD PLASTIC FLUTED DRIVE PINS**

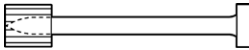

.145 Shank Diameter in Shank Lengths from 1/2" to 1-1/2"

**.300 HEAD PLASTIC FLUTED DRIVE PINS WITH 7/8" WASHER**

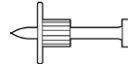

.145 Shank Diameter in Shank Lengths from 1" to 2"

**1/4" - 20 THREADED STUDS**



.145 Shank Diameter in Shank Lengths of 1/2" and 1" and Thread Lengths of 1/2", 3/4" and 1" Maximum overall fastener length is 1-1/2" for the Model 721 tool.

**.300 HEAD POWER POINT PLASTIC FLUTED DRIVE PINS**

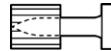

.150 Straight Shank in Shank Lengths from 1/2" to 7/8"

.150/.180 Step Shank in Lengths from 1" to 1-1/4"

**8 mm HEAD TOP-HAT DRIVE PINS**



.145 Shank Diameter in Shank Lengths from 1/2" to 1"

**CEILING CLIP ASSEMBLIES**



Ceiling Clip with 1" or 1-1/4" premounted .145 Shank Pin and Ceiling Clip with 1" or 1-1/4" Premounted .150/.180 Shank Pin

**CONDUIT CLIP ASSEMBLIES**



For 1/2" and 3/4" Diameter Conduit with 1" Premounted Fastener

## LOADS

Ramset .22 cal. CW loads are specially made for use in the Model 721 Tool.

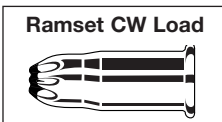

The power level of the load is indicated by the number marked on each box, the color of the box, and the color on the tip of each load. As the number increases, the power level also increases.

POWER LEVEL	CATALOG NUMBER	LOAD COLOR	CASE COLOR
2	22CW	Brown	Brass
3	32CW	Green	Brass
4	42CW	Yellow	Brass

Always perform the center punch test described on page 3 to test the base material.

Always make a test fastening using the lowest power level first. If more power is required to set the fastener, use the next higher power level until the power level necessary to drive the fastener is reached.

# FASTENERS / LOADS

# FASTENING APPLICATIONS

---

## FASTENING APPLICATIONS

Your Ramset tool can be used for a wide range of fastening needs in a variety of base materials. Reading and follow these important fastening guidelines will help you get the best results from your tool, fasteners, and powder loads, as well as help you perform these fastening operations safely and effectively.

Powder actuated fastenings are permanent fastening so attempting to remove a fastener from concrete or steel may result in serious injury.

### Fastening to Concrete

When fastening into concrete, always maintain a minimum spacing of 3" between fastenings and 3" from any free edge. Concrete thickness should be at least three times the intended penetration depth into the concrete. The primary exception to the 3" edge distance can occur in a sill plate application where, by necessity, the edge distance is reduced.

Driving fasteners too close to an edge or too close to each other can cause the concrete edge to fail or fasteners to fly free.

### Fastening to Concrete Block or to Masonry Walls

While this application is not recommended, when used, it is necessary to take care to observe a 3" edge distance to avoid cracking the block and over penetration of the fastener to avoid loss of holding value. Fastening may be made into the horizontal joint but not into the vertical joint.

### Fastening to Steel

Your Ramset tool can be used for fastening on the flat surfaces of structural steel. When fastening into steel, always maintain a minimum spacing of 1-1/2" between fastenings and 1/2" from any edge.

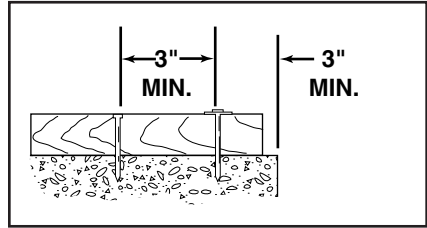

SPACING WOOD TO CONCRETE

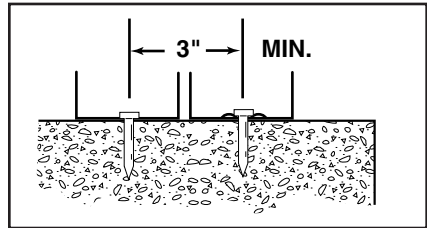

PENETRATION — THIN GAUGE METAL TO CONCRETE

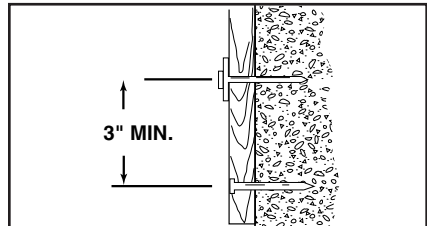

SPACING — FURRING STRIP TO CONCRETE

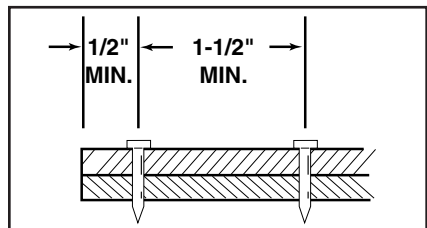

SPACING — STEEL TO STEEL

---

# FASTENING APPLICATIONS



---

## TOOL OPERATING INSTRUCTIONS

### TOOL OPERATION

#### Daily Function Test

**Always check the tool first to make sure that it does not contain a load or fastener.**

Test the tool several times by depressing the muzzle bushing fully on a hard surface and pulling the trigger. You should hear an audible click as the firing pin releases. Let up on the tool and check to be sure that the barrel has opened to the full open position.

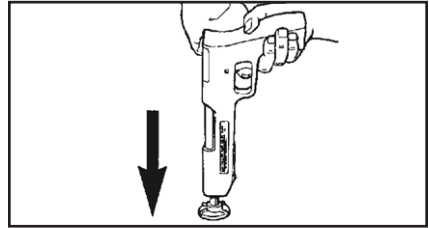

**PERFORM FUNCTION TEST WITH EMPTY, UNLOADED TOOL**

### OPERATING THE MODEL 721

1. After checking to be sure that the tool is not loaded, point it in a safe direction and snap the barrel open with a quick downward motion. This action positions the piston in preparation for the next fastening. Use the spall guard every time possible to minimize the risk of being struck by flying debris.
2. With finger off the trigger, place the fastener, point out, into the muzzle end of the tool until the point end is inside the muzzle. **NEVER** load a fastener with your finger on the trigger. **DO NOT** use excessive force when inserting a fastener. **STOP** immediately if excessive force is required, inspect the barrel to find out why the fastener is not entering the muzzle freely. **DO NOT** continue loading unless the problem is corrected.
3. With the tool pointed in a safe direction the barrel fully open, and your finger away from the trigger, make sure the chamber is clear and insert a load into the tool chamber. Always start with the lowest power level. If this load does not fully set the fastener, try the next higher power level until the proper power level is found.

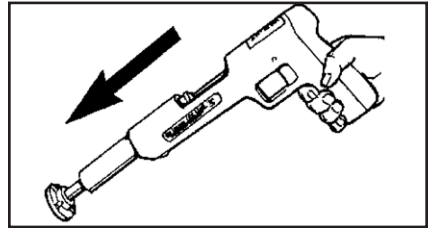

**SLIDE THE BARREL FORWARD**

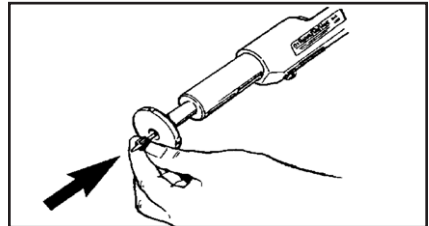

**INSERT FASTENER INTO THE MUZZLE END OF THE TOOL WITH THE POINT OUT**

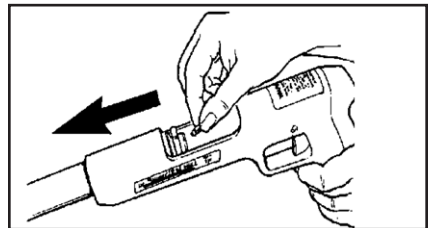

**INSERT A LOAD INTO INTO THE TOOL CHAMBER**

## TOOL OPERATING INSTRUCTIONS

---

- Slide the barrel back to the semi-closed position. **Never** attempt to close the tool by exerting force on the front end of the barrel. **Never place your hand, fingers or any other body part over the fastener loading end of the tool.**
- Hold the tool perpendicular (90°) to the work surface with both hands and press firmly to fully depress the tool. Maintain firm downward pressure on the tool with both hands and pull the trigger to drive the fastener. **DO NOT DEPRESS THE TOOL AGAINST ANYTHING OTHER THAN THE INTENDED WORK SURFACE.** Holding the tool firmly in place will produce more consistent fastening quality and minimize tool wear or damage.
- After making the fastening, point the tool in a safe direction, and snap the tool downward to cause the barrel to move to the open position. This action ejects the fired load case and properly resets the piston for the next fastening. Should a fired load fail to eject, open and close the tool several times to loosen the load in the chamber, then remove the load with your fingers. **Never attempt to pry an unfired load out of the tool chamber.** The load could be caused to discharge resulting in a serious injury or death to the tool operator or to a bystander.
- Insert another fastener in the muzzle end of the tool before inserting a new powder load into the chamber. **Always insert the fastener into the tool before inserting the powder load.** Keep your finger off of the trigger until the tool is in position to drive the fastener. **Never carelessly discard or throw unfired powder loads into a trash container.**

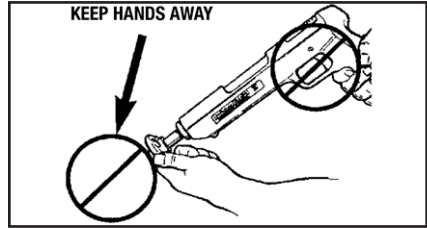

SLIDE THE BARREL BACKWARD TO THE SEMI-CLOSED POSITION

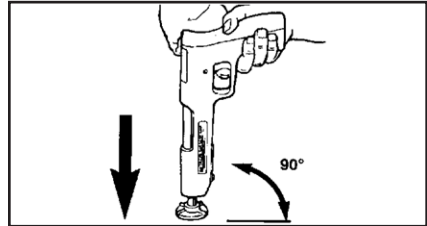

HOLD TOOL FIRMLY AND PERPENDICULAR TO THE WORK SURFACE

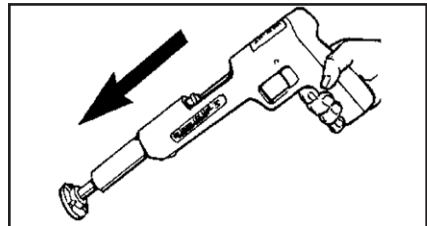

EJECT THE LOAD

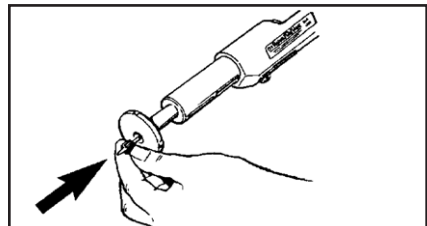

INSERT THE NEXT FASTENER

---

## TOOL OPERATING INSTRUCTIONS

# TROUBLESHOOTING

## REFER TO PARTS SCHEMATIC FOR PROPER ASSEMBLY OF PARTS

- Overdriving of fasteners	- Excessive power	- Change to the next lower power level load color and number.
	- Soft base material	- Check base material (see page 3)
- Tool fails to fire	- Failure to depress completely	- See "Tool does not completely depress"
	- Excessive dirt buildup on breech face not allowing proper penetration of firing pin	- After following misfire procedure, check firing pin indentation on load and clean breech face.
	- Firing pin and/or breech damaged	- Replace damaged parts
- Tool does not completely depress	- Misassembled or damaged parts	- Check all parts in the receiver for damage or improper assembly.
- Reduction or loss of power	- Piston not being returned to the full rear position	- The barrel must be pulled completely open to properly position the piston.
	- Worn or damaged piston or piston ring	- Replace missing, worn or damaged parts.
	- Worn or broken stop pin	- Replace stop pin
- Fired load will not extract	- Tool not being fully opened	- Barrel must be pulled out fully to allow piston tip to eject the load case.
	- Damaged or bent piston	- Replace piston
	- Loose breech plug	- Tighten breech plug.
	- Dirt buildup in the breech	- Clean breech
	- Stuck powder load	- Remove barrel assembly from tool and unscrew the breech plug. Gently push out load using a brass rod. DANGER: If the load has not been fired, use extreme care to avoid causing the load to discharge.
- Piston stuck in down position	- Piston overdriven and stuck in piston stop	- Tap on a hard surface or drive back with brass or lead hammer.
- Barrel opens too easily	- Stop pin spring is too weak	- Replace spring
- Barrel will not slide open or is very hard to open	- Bent piston	- Replace piston
	- Excessive dirt buildup	- Disassemble & clean tool
	- Stop pin damaged	- Replace stop pin
	- Debris jammed between barrel & receiving housing	- Disassemble & remove debris
- Chipped or damaged piston tip	- Tool not being held squarely to the work surface. This allows the piston to slip off of the head of the fastener and cause piston tip damage.	- Grind the end of the piston as shown on page 15. Grinding should only be done by a qualified individual.

PARTS SCHEMATIC

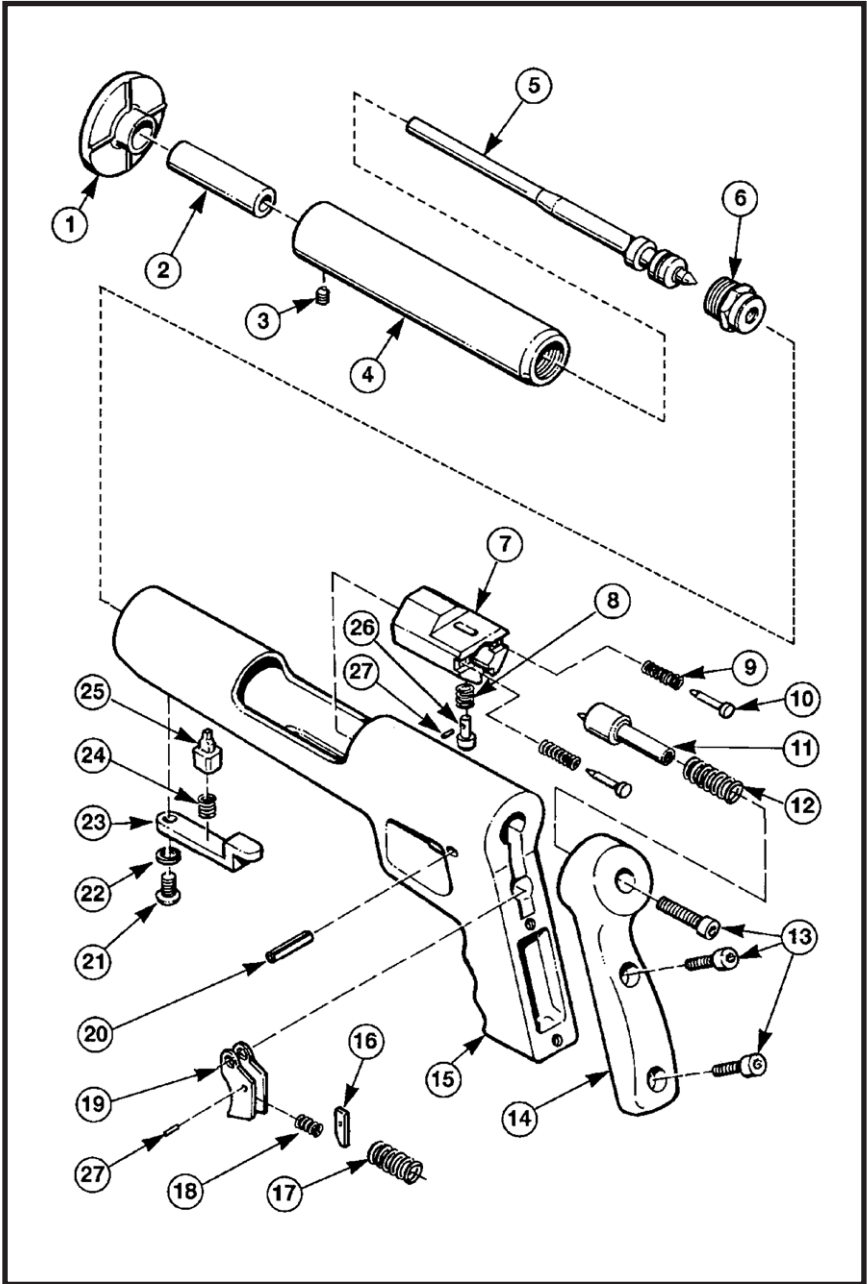

---

## PARTS LIST / MAINTENANCE

### MODEL 721 TOOL PARTS LIST

KEY	PART NO.	DESCRIPTION
1	12266	SPALL GUARD
2	12258	BARREL EXTENSION
3	12260	BARREL EXTENSION SCREW
4	12108	BARREL ASSEMBLY
5	33657	PISTON/RING ASSEMBLY
6	33650	BREECH PLUG
7	33640	BREECH BLOCK
8	33659	SEAR SPRING
9	33642	BREECH BLOCK SPRING
10	33641	BREECH BLOCK SPRING PIN
11	12085	FIRING PIN
12	33658	FIRING PIN SPRING
13	33674	HANDLE/FIRING PIN SCREW
14	81681	RUBBER HANDLE
15	22101	HOUSING ASSEMBLY
16	33667	TRIGGER BAR
17	33647	TRIGGER SPRING
18	33668	TRIGGER BAR SPRING
19	33646	TRIGGER
20	12476	TRIGGER ROLL PIN
21	22798	STOP PIN COVER SCREW
22	22790	LOCK WASHER
23	22088	STOP PIN COVER
24	12388	STOP PIN SPRING
25	33645	STOP PIN
26	81649	SEAR
27	33671	SEAR/TRIGGER BAR ROLL PIN
30	33679	RUBBER BUMPER (NOT SHOWN)

---

### MAINTENANCE

**IMPROPERLY MAINTAINED TOOLS CAN CAUSE SERIOUS INJURIES  
TO TOOL OPERATOR AND BYSTANDERS  
CLEAN TOOL DAILY**

Always make sure the tool is not loaded before performing any service or repair and always wear safety goggles when cleaning or servicing the tool.

#### NORMAL CLEANING

All front end parts shown in the disassembly section are to be cleaned daily with a good detergent oil and wire brush. Remove all dirt and carbon buildup and wipe parts dry with a clean rag. Check all parts for wear or damage before reassembly and replace or repair any worn or damaged parts.

#### COMPLETE CLEANING / GENERAL MAINTENANCE

Heavy or constant exposure to dirt and debris may require that the tool be cleaned more extensively. Complete disassembly and cleaning of all parts may be necessary to restore the tool to normal operation. General maintenance should be performed every six months or more often if the tool is subjected to heavy use. Contact your authorized Ramset Distributor for assistance.

**ALWAYS FUNCTION TEST THE TOOL AFTER PERFORMING ANY SERVICE.  
SEE PAGE 9 FOR DETAILS ON THE FUNCTION TEST.**

---

## PARTS LIST / MAINTENANCE

# DISASSEMBLY

---

## TOOL DISASSEMBLY

1. Remove the screw and lockwasher from the stop pin cover using the 5/32" hex wrench provided with the tool.

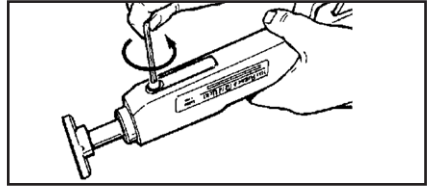

**REMOVE STOP PIN COVER,  
SCREW & LOCKWASHER**

2. Remove the stop pin cover by lifting it up and out of the tool housing.

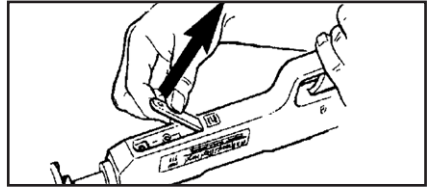

**REMOVE STOP PIN COVER**

3. Remove the stop pin spring.

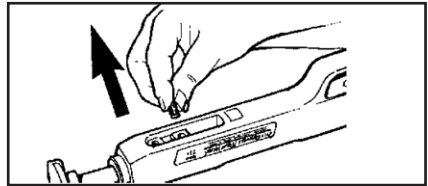

**REMOVE STOP PIN SPRING**

4. Remove the stop pin.

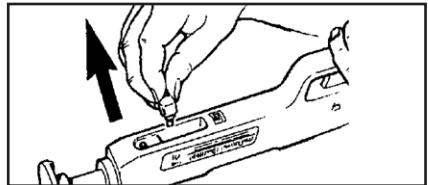

**REMOVE THE STOP PIN**

5. Slide the barrel assembly out of the tool housing. Note the alignment of the slot in the barrel with the stop opening in the tool housing.

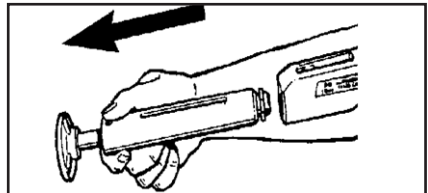

**SLIDE THE BARREL OUT OF THE  
TOOL HOUSING**

---

# DISASSEMBLY

6. Unscrew the breech plug from the rear of the barrel using a 1" wrench. Protect the barrel from damage if a vise is used to hold the barrel during the disassembly.
7. Slide the piston out of the barrel assembly. If necessary, tap the breech plug end of the barrel on a wood block to free the piston.
8. Inspect all parts for wear or damage and clean or replace as required. Use detergent oil and cleaning brush. Wipe parts dry before reassembly.  
**WEAR SAFETY GOGGLES WHEN CLEANING TOOL PARTS.**
9. Check the piston tip for mushrooming or other deformities, and grind flat. The tip of the piston must be  $90^\circ$  to the shank and grinding must only be done by qualified personnel. The overall minimum length of the piston must not be less than  $6\text{-}1/16"$ . When less than this length, the piston must be replaced to avoid tool damage.
10. Inspect all tool parts for wear or damage and clean or replace as required. Wipe all parts dry before reassembly.
11. Reassemble the tool in the reverse order of disassembly. Align the stop groove in the barrel with the stop opening in the tool housing when replacing the barrel.

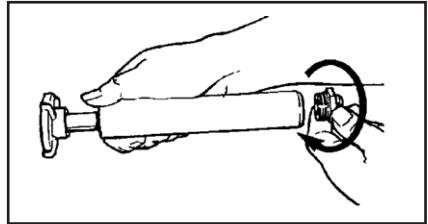

**UNSCREW THE BREECH PLUG FROM THE BARREL**

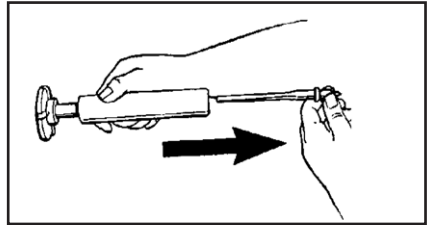

**SLIDE THE PISTON FROM THE REAR OF THE BARREL**

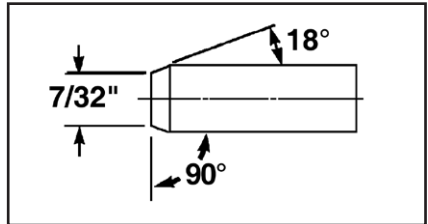

**GRIND PISTON TIP FLAT AND BEVEL EDGE AT  $18^\circ$**

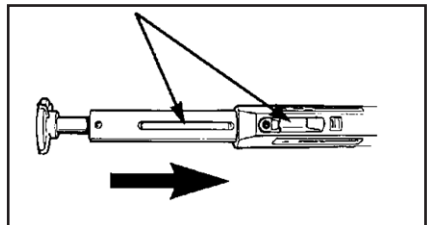

**ALIGN STOP GROOVE IN THE BARREL WITH STOP OPENING**

**ALWAYS PERFORM THE DAILY FUNCTION TEST BEFORE USING THE TOOL AFTER CLEANING OR SERVICING.**

# 721 WARRANTY AND LIMITATIONS

Ramset warrants that new 721 power fastening tools, parts and accessories will be free from defects in material and workmanship for the period shown below.

### THREE-YEAR WARRANTY

A three-year warranty will apply to all parts, except those listed below as normal wearing parts, or parts which are specifically covered by an extended warranty.

The following parts are considered normal wearing parts and are excluded from the warranty:

- Piston
- Buffer
- Spring Clips
- Pawls
- Piston Rings

The warranty period is based off of tool build date, determined from the tool serial number. Ramset may extend the warranty time frame from the date of purchase with a qualifying document proving date of purchase.

### WARRANTY STATEMENT

Ramset's sole liability hereunder will be to replace any part or accessory which proves to be defective within the specific time period. Any replacement part or accessory provided in accordance with this warranty will carry a warranty for the balance of the period of warranty applicable to the part it replaces. This warranty does not apply to part replacement required due to normal wear.

This warranty is void as to any tool which has been subjected to misuse, abuse, accidental or intentional damage, use with fasteners, and loads not meeting Ramset specification, size, or quality, improperly maintained, repaired with other than genuine 721 replacement parts, damaged in transit or handling, or which, in Ramset's opinion, has been altered or repaired in a way that affects or detracts from the performance of the tool.

Ramset MAKES NO WARRANTY, EXPRESSED OR IMPLIED, RELATING TO MERCHANTABILITY, FITNESS, OR OTHERWISE, EXCEPT AS STATED ABOVE and the liability AS STATED ABOVE AND AS ASSUMED ABOVE is in lieu of all other warranties arising out of, or in connection with, the use and performance of the tool, except to the extent otherwise provided by applicable law.

Ramset SHALL IN NO EVENT BE LIABLE FOR ANY DIRECT, INDIRECT, OR CONSEQUENTIAL DAMAGES, INCLUDING, BUT NOT LIMITED TO DAMAGES WHICH MAY ARISE FROM LOSS OF ANTICIPATED PROFITS OR PRODUCTION, SPOILAGE OF MATERIALS, INCREASED COST OF OPERATION OR OTHERWISE.

Ramset reserves the right to change specifications, equipment, or designs at any time without notice and without incurring obligation.

Copyright 2008 Ramset



**THE MODEL 721 TOOL COMPLIES WITH OSHA REQUIREMENTS AND WITH ANSI A10.3 SPECIFICATIONS**

**FOR TOOL REPAIR SERVICE CONTACT YOUR LOCAL AUTHORIZED RAMSET DISTRIBUTOR OR TO FIND YOUR NEAREST RAMSET TOOL REPAIR CENTER VISIT OUR WEB SITE AT [WWW.RAMSET.COM](http://WWW.RAMSET.COM) OR CALL 800-241-5640**



**Concrete Fastening Systems  
Glendale Heights, IL 60139  
800-RAMSET6 (1-800-726-7386)  
[www.ramset.com](http://www.ramset.com)**

**Buy with Confidence...  
Buy From Your Authorized Distributor**

**AN ILLINOIS TOOL WORKS COMPANY  
© ILLINOIS TOOL WORKS 2008**